

VR75-6-3000PS Torsion spring

Images:

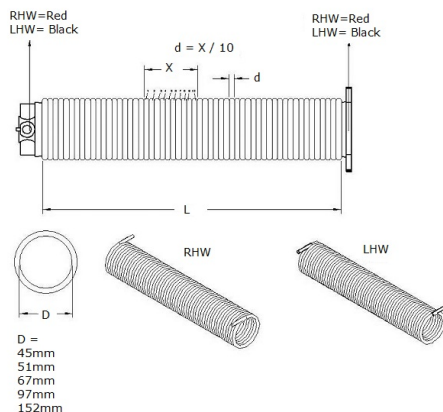

Description:

- | | |
|--------------------------|---|
| - Subcategory | : 01. Powder Coated |
| - IND/RES | : IND |
| - Full package quantity | : 1 |
| - Unit | : piece (1) |
| - Weight / Unit | : 69,3kg |
| - Material | : Spring Steel |
| - Colour | : Blue |
| - Length | : 3000mm |
| - Product Family | : a 020 |
| - Inside diameter | : 152mm |
| - Spring wire diameter | : 7,5mm |
| - Commercial description | : Making powder coated springs available on standard lengths! |
| - Technical description | : Produced by FlexiForce Hungary, spring wire has, after coiling, received shot peening treatment, powder coating and heat treatment. Coating blue-grey (RAL5014). High-quality appearance! Also available as pre-assembled, fix-to-size spring. Check our spring production movie! |