

VL90-3-3000PS Torsion spring

Images:

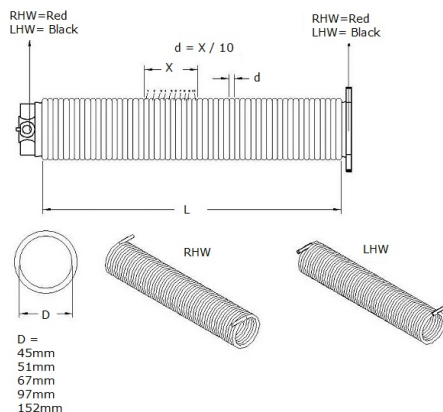

Description:

- Subcategory	: 01. Powder Coated
- IND/RES	: IND
- Full package quantity	: 1
- Unit	: piece (1)
- Weight / Unit	: 54,2kg
- Material	: Spring Steel
- Colour	: Blue
- Length	: 3000mm
- Product Family	: a 029
- Inside diameter	: 95mm
- Spring wire diameter	: 9mm
- Commercial description	: Making powder coated springs available on standard lengths!
- Technical description	: Produced by FlexiForce Hungary, spring wire has, after coiling, received shot peening treatment, powder coating and heat treatment. Coating blue-grey (RAL5014). High-quality appearance! Also available as pre-assembled, fix-to-size spring. Check our spring production movie!