

TSC880-2735 Tension spring

Images:

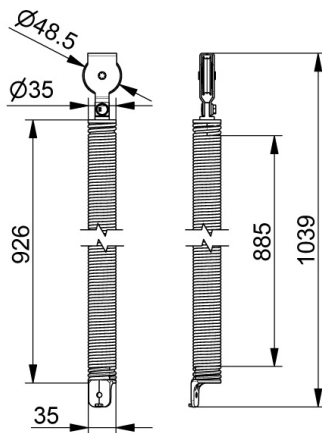

Description:

- Subcategory	: 01. Tension springs
- IND/RES	: RES
- Full package quantity	: 8
- Unit	: set (1)
- Weight / Unit	: 3,07kg
- Material	: Galvanised spring wire
- Length	: 1060mm
- Width	: 39mm
- Product Family	: a 047
- Inside diameter	: 35mm
- Max. cable diameter	: 2,4mm
- Max. door weight	: 60kg
- Max. performance	: Max. OPH = 2500mm
- Outside diameter	: 48,5mm
- Marking	: TSC880-....
- Technical description	: Balancing the door weight. The spring is mounted inside the vertical track set RSCVT..Z. The spring is completely pre-assembled with lower connection bracket, spring-in-spring and with top bracket including pulley wheel. See manual and separate selection table.