

RSCVTC20Z Vertical track set

Images:

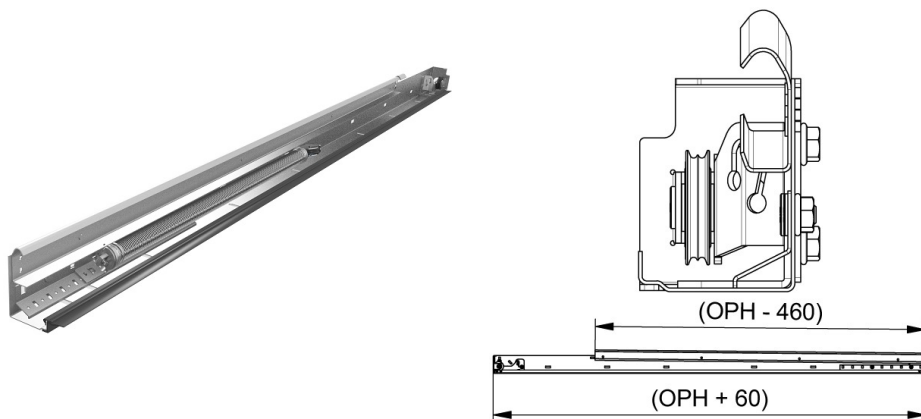

Description:

- Subcategory	: 02. Vertical track set / tension / RSCVTC
- IND/RES	: RES
- Full package quantity	: 25
- Unit	: pair (2)
- Weight / Unit	: 13,54kg
- Material	: Galvanised Steel
- Length	: 2185mm
- Thickness	: 1,5mm
- Product Family	: a 018
- Max. door weight	: 126kg
- Marking	: RSCVTC..Z FF
- Commercial description	: Part of updated RSC-T residential tension spring system.
- Technical description	: Pre-assembled, riveted, vertical track set consists of vertical angle (915VL), closed C track (215VC) and integrated connection for TSC springs. Add side seal 1088, 1088T or 1088TF for optimum isolation.