

RSCVT50Z Vertical track set

Images:

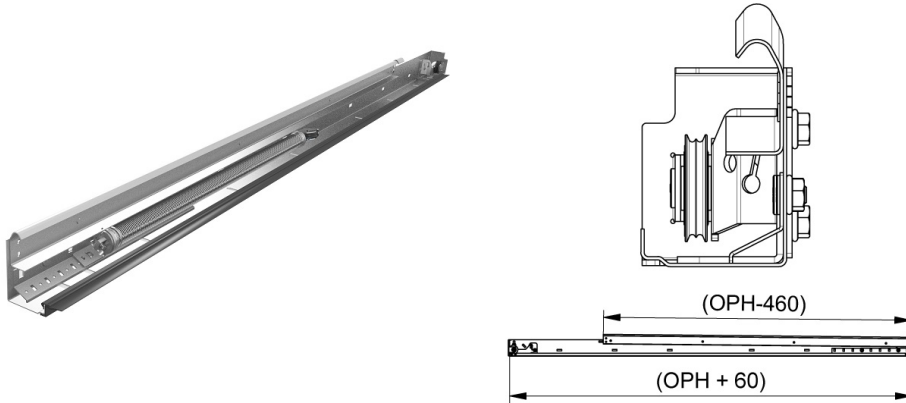

Description:

- Subcategory	: 01. Vertical track set / tension / RSCVT
- IND/RES	: RES
- Full package quantity	: 25
- Unit	: pair (2)
- Weight / Unit	: 15,8kg
- Material	: Galvanised Steel
- Length	: 2560mm
- Thickness	: 1,5mm
- Product Family	: a 011
- Marking	: RSCVT..Z FF
- Commercial description	: Part of updated RSC-T residential tension spring system.
- Technical description	: Pre-assembled, riveted, vertical track set consists of vertical angle (915VL..), open track (215V..), integrated connection for TSC springs and pre-assembled top pulley. Add side seal 1088! See manual for installation.