

RSCVLC60Z Vertical track set

Images:

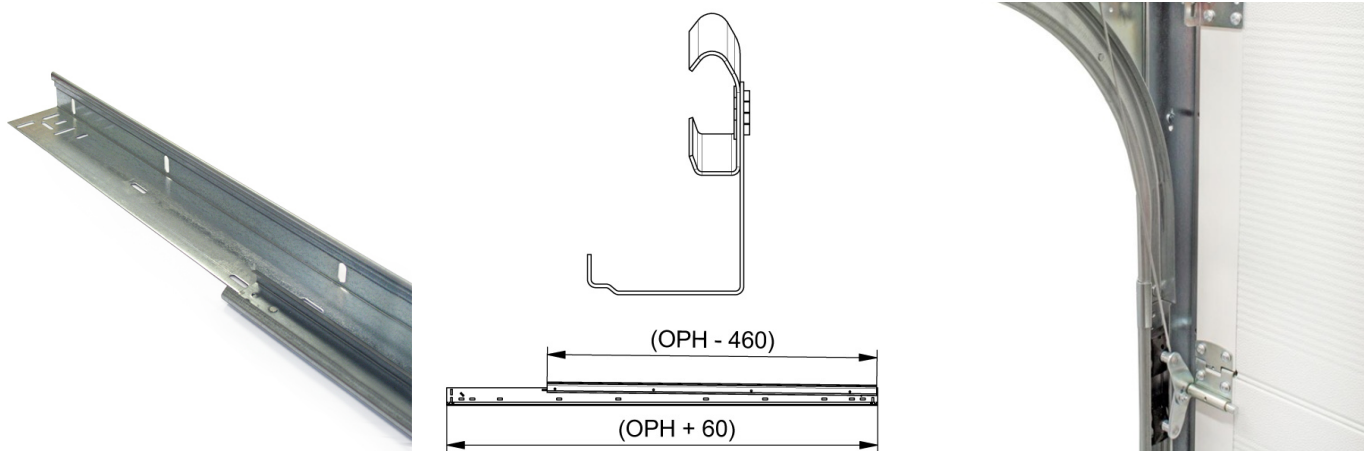

Description:

- Subcategory	: 04. Vertical track set / torsion / RSCVLC
- IND/RES	: RES
- Full package quantity	: 25
- Unit	: pair (2)
- Weight / Unit	: 15,78kg
- Material	: Galvanised Steel
- Length	: 2810mm
- Thickness	: 1,5mm
- Product Family	: a 034
- Max. door weight	: 225kg
- Marking	: RSCVLC..Z FF
- Technical description	: Pre-assembled, riveted, vertical track set consists of vertical angle (915VL) and closed C track (215VC). Add side seal 1088, 1088T or 1088TF for optimum isolation.