

RSCVLA2250Z Vertical track set

Images:

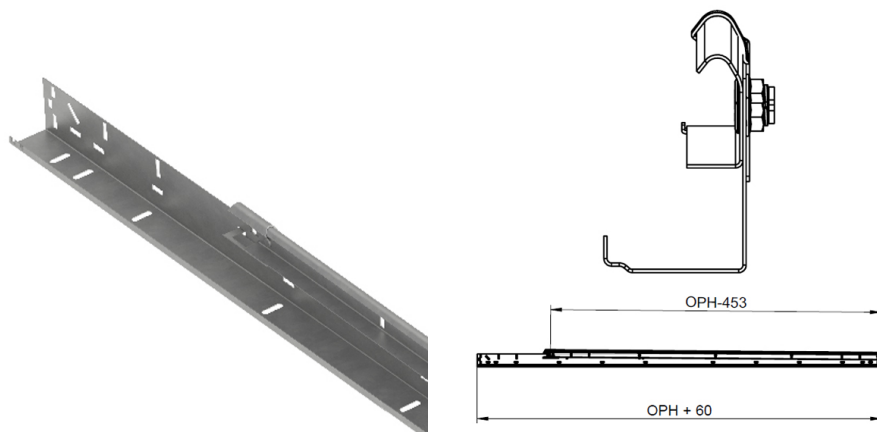

Description:

- IND/RES	: RES
- Full package quantity	: 25
- Unit	: pair (2)
- Weight / Unit	: 13,3kg
- Material	: Galvanised Steel
- Length	: 2310mm
- Thickness	: 1,5mm
- Product Family	: a 001
- Max. door weight	: 225kg
- Commercial description	: RSC Bolted, vertical set (L+R), 915VLH, OPH 2250mm
- Technical description	: vertical angle with 215V open guiding track and 870RSH connection socket, assembled for 40mm panels. After reassembly 60mm panels also possible. Height can be reduced by 2x 125mm without losing holes.