

RSCHM50 Horizontal track set

Images:

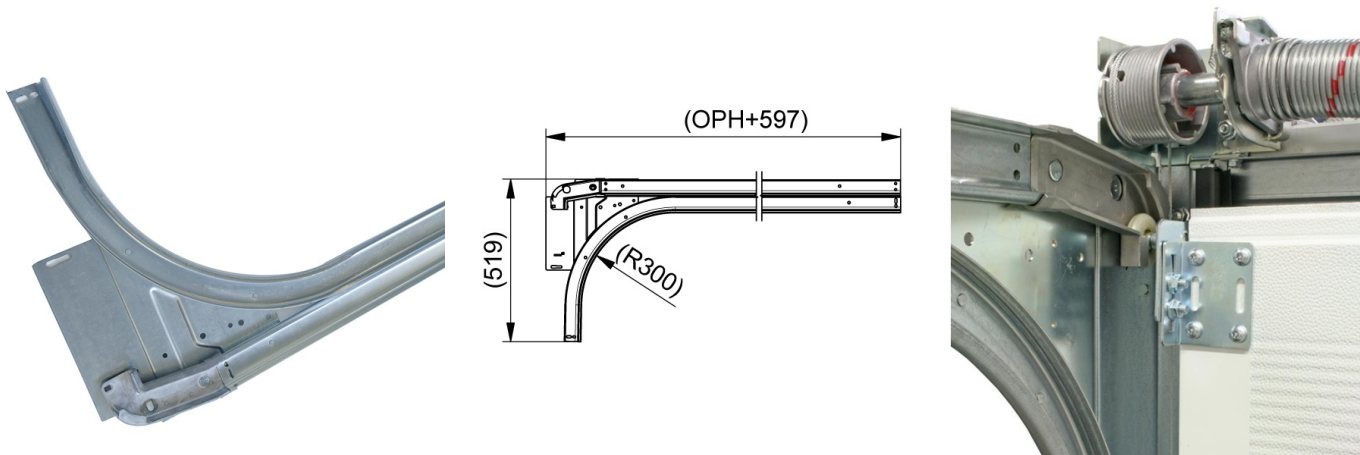

Description:

- Subcategory	: 08. Horizontal track sets / RSCHM
- IND/RES	: RES
- Full package quantity	: 25
- Unit	: pair (2)
- Weight / Unit	: 8,31kg
- Material	: Galvanised Steel
- Length	: 3097mm
- Thickness	: 1,5mm
- Product Family	: a 062
- Max. door weight	: 225kg
- Marking	: RSCHM FF
- Technical description	: Pre-assembled, riveted, horizontal track set consists of upper curves (215FL/R, burglar resistant!) lower curves (215G....-300), side plates and track connection plates (835). Order pulley construction separately for springs in rear. Combine with RSCVL(C) or RSCVB(C) vertical track sets.