

RSCHAS2375 Horizontal track set

Images:

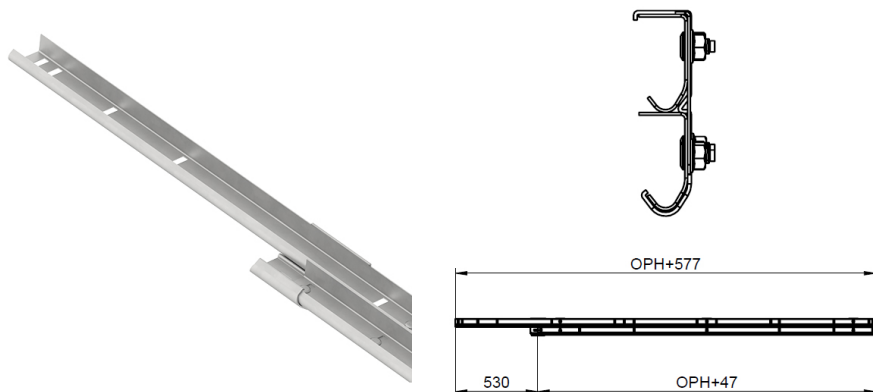

Description:

- | | |
|--------------------------|--|
| - IND/RES | : RES |
| - Full package quantity | : 25 |
| - Unit | : pair (2) |
| - Weight / Unit | : 12,89kg |
| - Material | : Galvanised Steel |
| - Thickness | : 1,5mm |
| - Product Family | : a 001 |
| - Max. door weight | : 225kg |
| - Commercial description | : RSC Bolted, horizontal set (L+R), straight, OPH 2375mm |
| - Technical description | : Double horizontal track 215V of which the upper track runs straight to the wall, without a curve. Use 215G300A0 for the bottom curve. Apply for torsion springs in rear and tension spring system. |