

RSCHA2500 Horizontal track set

Images:

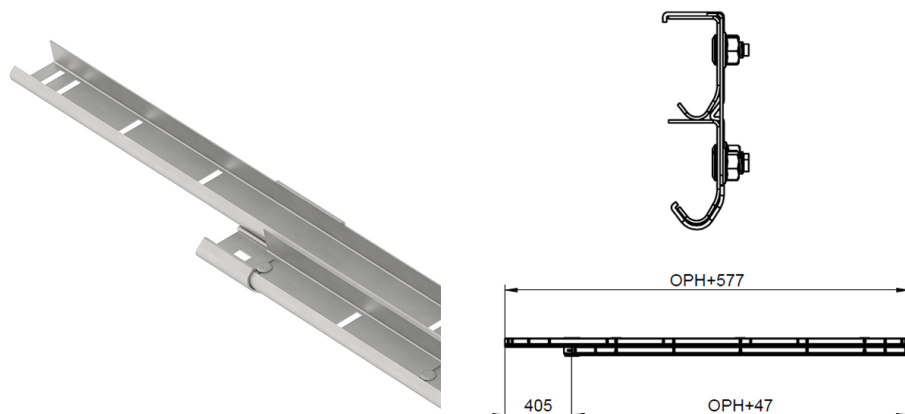

Description:

- | | |
|--------------------------|--|
| - IND/RES | : RES |
| - Full package quantity | : 25 |
| - Unit | : pair (2) |
| - Weight / Unit | : 13,16kg |
| - Material | : Galvanised Steel |
| - Thickness | : 1,5mm |
| - Product Family | : a 001 |
| - Max. door weight | : 225kg |
| - Commercial description | : RSC Bolted, horizontal set (L+R), alu curve, OPH 2500mm |
| - Technical description | : Double horizontal track 215V for a 215FHR/L aluminum top curve with roller lock-up. Use 215G300A0 for the bottom curve. Apply for torsion springs in front, torsion springs in rear and tension springs. |