

RSCHA2250 Horizontal track set

Images:

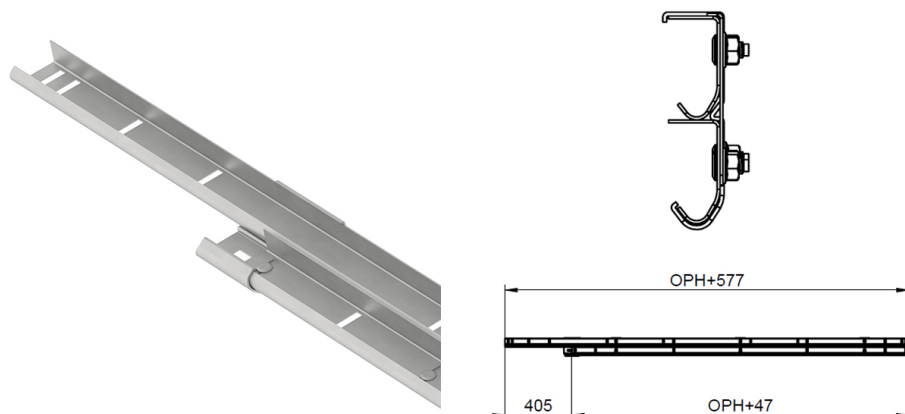

Description:

- IND/RES	: RES
- Full package quantity	: 25
- Unit	: pair (2)
- Weight / Unit	: 12,06kg
- Material	: Galvanised Steel
- Thickness	: 1,5mm
- Product Family	: a 001
- Max. door weight	: 225kg
- Commercial description	: RSC Bolted, horizontal set (L+R), alu curve, OPH 2250mm
- Technical description	: Double horizontal track 215V for a 215FHR/L aluminum top curve with roller lock-up. Use 215G300A0 for the bottom curve. Apply for torsion springs in front, torsion springs in rear and tension springs.