

9VL-H3985 Angle

Images:

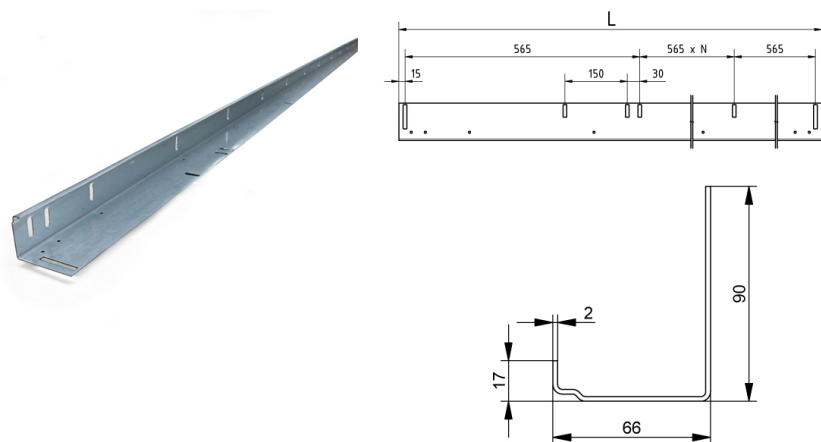

Description:

- Subcategory : Bolted tracks, Vertical Angles
- IND/RES : IND
- Full package quantity : 25
- Unit : piece (1)
- Weight / Unit : 7,77kg
- Material : Galvanised Steel
- Height : 66mm
- Length : 3985mm
- Width : 90mm
- Thickness : 2mm
- Product Family : a 154§
- Commercial description : Universal left/right. See ISC technical handbook for system details
- Technical description : The flange of 66mm has slotted holes 10,5x20mm every 300mm. The flange of 90mm has 2 slotted holes 9x40mm on both ends and each 565mm a slotted hole 9x30mm. Use for ISC bolted tracks. Always cut from the bottom, to keep the hole pattern in place.