

9VB6000 Angle

Images:

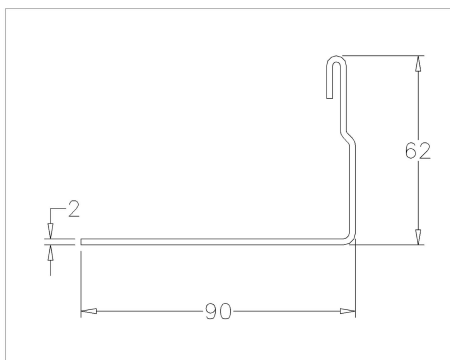
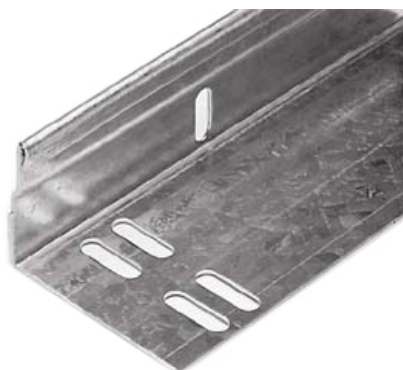

Description:

- | | |
|-------------------------|--|
| - Subcategory | : 02. Vertical Angles 2mm |
| - IND/RES | : IND |
| - Full package quantity | : 50 |
| - Unit | : piece (1) |
| - Weight / Unit | : 15,6kg |
| - Material | : Galvanised Steel |
| - Height | : 62mm |
| - Length | : 6000mm |
| - Width | : 90mm |
| - Thickness | : 2mm |
| - Product Family | : a 014 |
| - Technical description | : The flange of 62mm has slotted holes 9x25mm every 300mm. The flange of 90mm has on both ends 4 slotted holes 9x25mm. The vertical angle is suitable for side seal 1085, 1094-40. Other lengths available on request. |