

## 915VSX2303 Lintel profile

### Images:

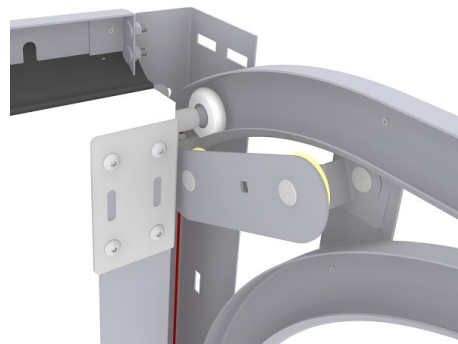
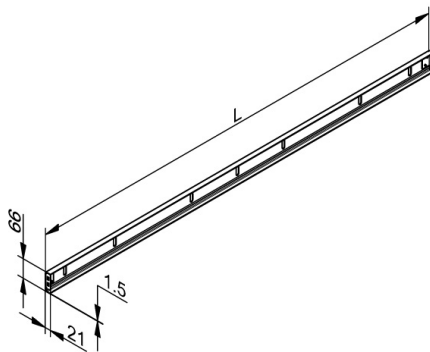
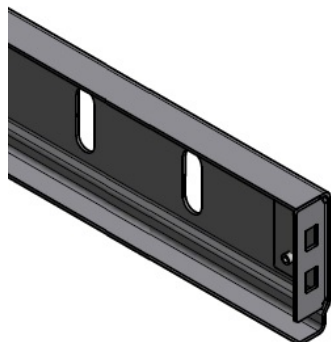

### Description:

- Subcategory	: 11. Lintel 915VSX
- IND/RES	: RES
- Full package quantity	: 50
- Unit	: piece (1)
- Weight / Unit	: 2,37kg
- Material	: Galvanised Steel
- Height	: 21mm
- Length	: 2303mm
- Width	: 66mm
- Thickness	: 1,5mm
- Product Family	: a 092
- Marking	: FF
- Technical description	: This angle, in combination with 1088 seal is often used as top sealing/distance profile on garage doors. With this solution, top panel can remain without seal and top-alu. Profile is foreseen with 2 end brackets for hook-into vertical track set holes. Easy installation!