

915VS-E6490 Lintel profile

Images:

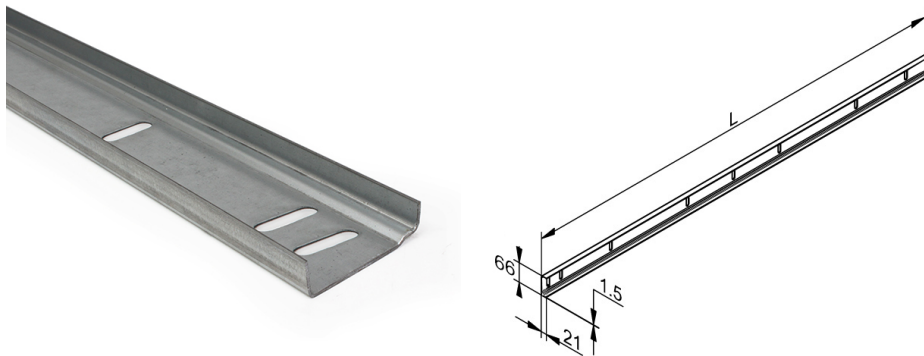

Description:

- Subcategory	: 11. Lintel 915VSX
- IND/RES	: BOTH
- Full package quantity	: 50
- Unit	: piece (1)
- Weight / Unit	: 7,15kg
- Material	: Galvanised Steel
- Height	: 21mm
- Length	: 6490mm
- Width	: 66mm
- Thickness	: 1,5mm
- Product Family	: a 090§
- Marking	: 915VS-E
- Commercial description	: Part of ISC-LHR system
- Technical description	: To reduce the total needed space above the track, a seal on the lintel is recommended. Use with 1088IT seal for optimum closing and alignment with side seals. Mount directly to the building, and connect the 1088IT seal to it.