

915VRA2290 Lintel profile

Images:

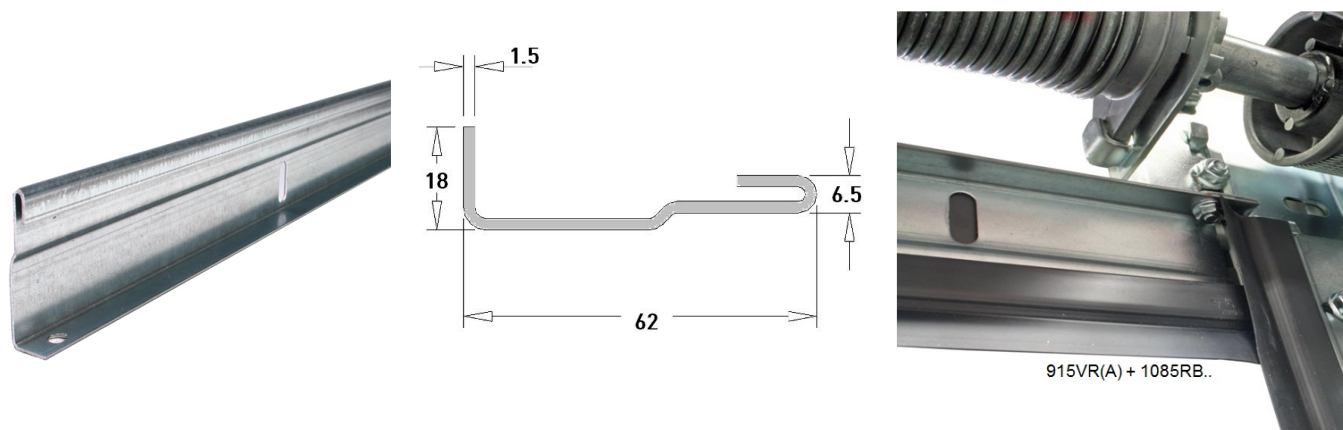

Description:

- Subcategory	: 12. Lintel 915VR(A)
- IND/RES	: RES
- Full package quantity	: 50
- Unit	: piece (1)
- Weight / Unit	: 2,43kg
- Material	: Galvanised Steel
- Height	: 18mm
- Length	: 2290mm
- Width	: 62mm
- Thickness	: 1,5mm
- Product Family	: a 106
- Marking	: FF
- Technical description	: This angle, in combination with 1085 seal or thermal break seal 1085RB.. is often used as top seal on the lintel of garage doors. With this solution, top panel can remain without seal and top-alu. Profile is foreseen with 2 holes for connecting to 563SL/R consoles. Easy installation!