

811H Rail connection plate, with holes

Images:

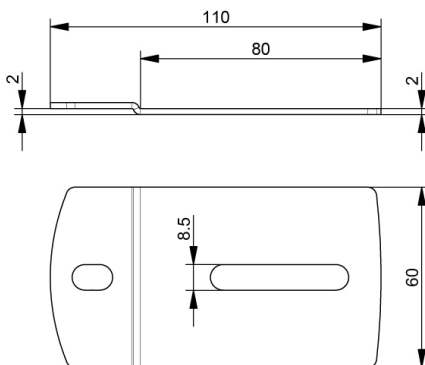

Description:

- Subcategory	: 03. ISC bolted tracks
- IND/RES	: IND
- Full package quantity	: 125
- Unit	: piece (1)
- Weight / Unit	: 0,095 kg
- Material	: Galvanised Steel
- Length	: 110mm
- Width	: 60mm
- Thickness	: 2mm
- Product Family	: a 002§
- Track width	: 2"
- Marking	: 811H FF
- Commercial description	: Part of ISC bolted tracks, for 40-80mm panels
- Technical description	: ISC tracksets are applied with a fixed lower and upper wedge. See technical handbook for track details. Use this plate for wedge sizes 86-135mm