

40EKL610R End cap

Images:

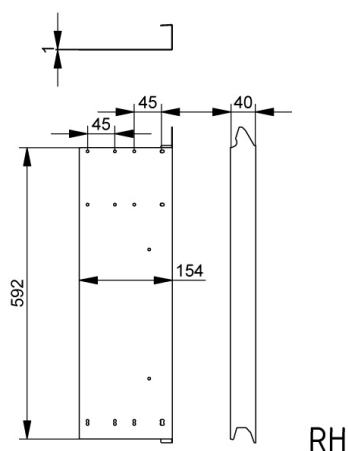

Description:

- Subcategory	: 19. Double (L), Kingspan and Epcó
- IND/RES	: RES
- Full package quantity	: 250
- Unit	: piece (1)
- Weight / Unit	: 0,99kg
- Material	: Galvanised Steel
- Height	: 592mm
- Length	: 610mm
- Width	: 154mm
- Thickness	: 1mm
- Product Family	: a 163§
- Fingersafe	: Yes
- Galvanised	: Yes
- Heart-to-heart	: 40mm
- Left / Right	: Right
- Panel thickness	: 40mm
- Commercial description	: Replaces 40PL610R and 40EL610R
- Technical description	: This universal end cap is universal for Kingspan and Epcó panels. It contains a hole pattern that matches both versions of hinges, to match the reinforcement lip in the panel