

## 2V-H6245 Vertical door track

Images:

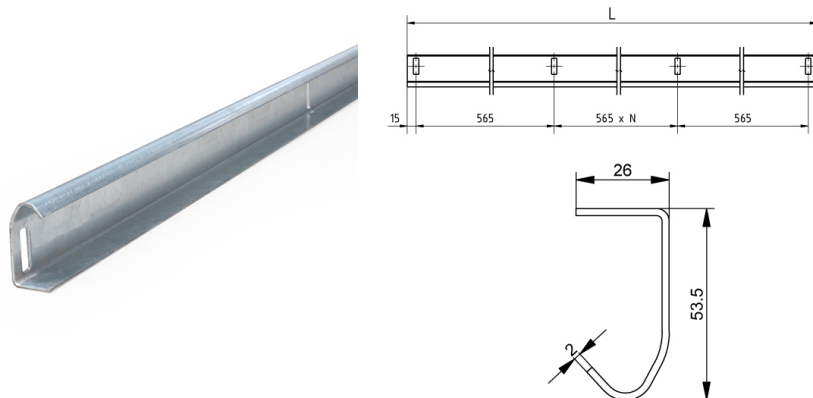

### Description:

- |                          |   |
|--------------------------|---|
| - Subcategory            | : Bolted tracks, Tracks   |
| - IND/RES                | : IND   |
| - Full package quantity  | : 25  |
| - Unit                   | : piece (1)   |
| - Weight / Unit          | : 8,99kg  |
| - Material               | : Galvanised Steel  |
| - Length                 | : 6245mm  |
| - Width                  | : 53,5mm  |
| - Thickness              | : 2mm   |
| - Product Family         | : a 151§  |
| - Commercial description | : Universal left/right. See ISC technical handbook for system details   |
| - Technical description  | : Profile is provided with rectangular holes 27x9mm at each 565mm for bolted connections. Use in combination with 9VL-H and 215C-H profiles. Connect with 1071BFN bolt and 1068M nut. |