

2V-H1725 Vertical door track

Images:

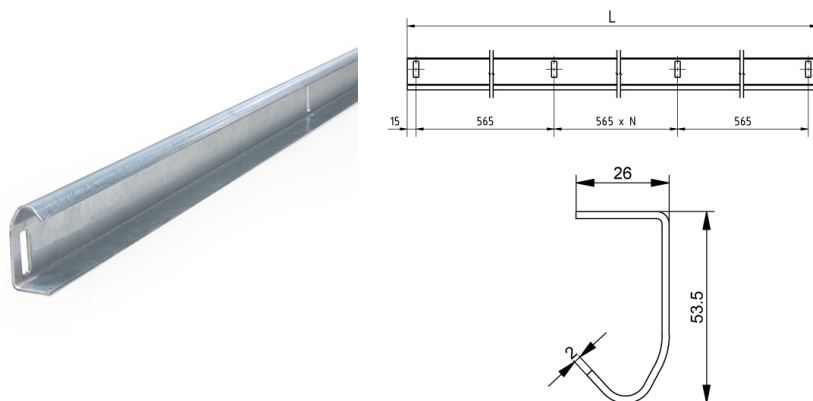

Description:

- | | |
|--------------------------|---|
| - Subcategory | : Bolted tracks, Tracks |
| - IND/RES | : IND |
| - Full package quantity | : 25 |
| - Unit | : piece (1) |
| - Weight / Unit | : 2,47kg |
| - Material | : Galvanised Steel |
| - Length | : 1725mm |
| - Width | : 53,5mm |
| - Thickness | : 2mm |
| - Product Family | : a 143§ |
| - Commercial description | : Universal left/right. See ISC technical handbook for system details |
| - Technical description | : Profile is provided with rectangular holes 27x9mm at each 565mm for bolted connections. Use in combination with 9VL-H and 215C-H profiles. Connect with 1071BFN bolt and 1068M nut. |