

2G1500-380-05 Curve

Images:

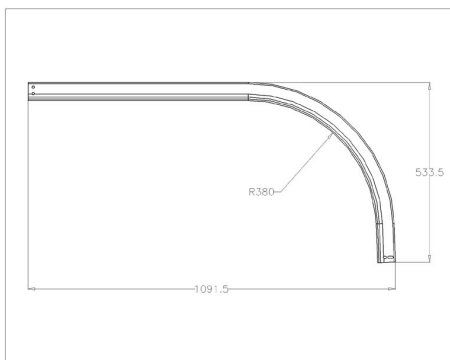

Description:

- Subcategory	: 04. 2G
- IND/RES	: IND
- Full package quantity	: 50
- Unit	: piece (1)
- Weight / Unit	: 2,2kg
- Material	: Galvanised Steel
- Length	: 1091,5mm
- Width	: 533,5mm
- Thickness	: 2mm
- Product Family	: a 016
- Inside diameter	: 380mm
- Track width	: 2"
- Technical description	: One end is provided with 2 round holes diameter 7mm, the other end is provided with a slotted hole and a round hole. The end of the bend has a 100mm long straight part. The given length indicates the length inmm, before bending.