

215V3180 Vertical door track

Images:

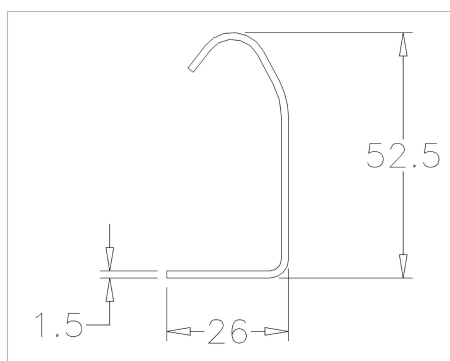

Description:

- Subcategory	: 04. Tracks 1,5mm
- IND/RES	: RES
- Full package quantity	: 50
- Unit	: piece (1)
- Weight / Unit	: 3,48kg
- Material	: Galvanised Steel
- Length	: 3180mm
- Width	: 52,5mm
- Thickness	: 1,5mm
- Product Family	: a 037
- Technical description	: Both ends are provided with 2 round holes of 7mm diameter. Other lengths available on request.