

## 215V2250 Vertical door track

### Images:

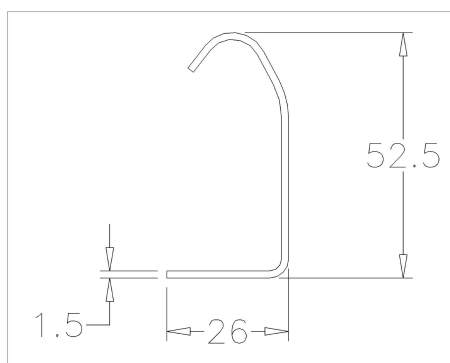

### Description:

- |                         |   |
|-------------------------|---|
| - Subcategory           | : 04. Tracks 1,5mm  |
| - IND/RES               | : RES   |
| - Full package quantity | : 50  |
| - Unit                  | : piece (1)   |
| - Weight / Unit         | : 2,45kg  |
| - Material              | : Galvanised Steel  |
| - Length                | : 2250mm  |
| - Width                 | : 52,5mm  |
| - Thickness             | : 1,5mm   |
| - Product Family        | : a 034   |
| - Technical description | : Both ends are provided with 2 round holes of 7mm diameter.<br>Other lengths available on request. |