

215V2050 Vertical door track

Images:

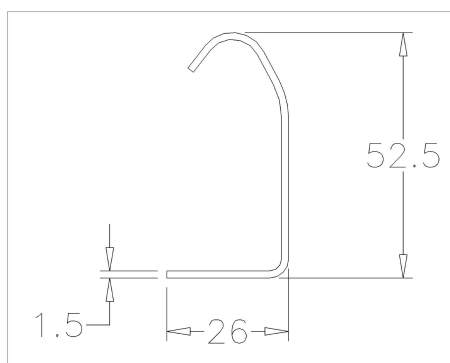

Description:

- | | |
|-------------------------|---|
| - Subcategory | : 04. Tracks 1,5mm |
| - IND/RES | : RES |
| - Full package quantity | : 50 |
| - Unit | : piece (1) |
| - Weight / Unit | : 2,25kg |
| - Material | : Galvanised Steel |
| - Length | : 2050mm |
| - Width | : 52,5mm |
| - Thickness | : 1,5mm |
| - Product Family | : a 033 |
| - Technical description | : Both ends are provided with 2 round holes of 7mm diameter.
Other lengths available on request. |