

215C-H5805 C-Profile

Images:

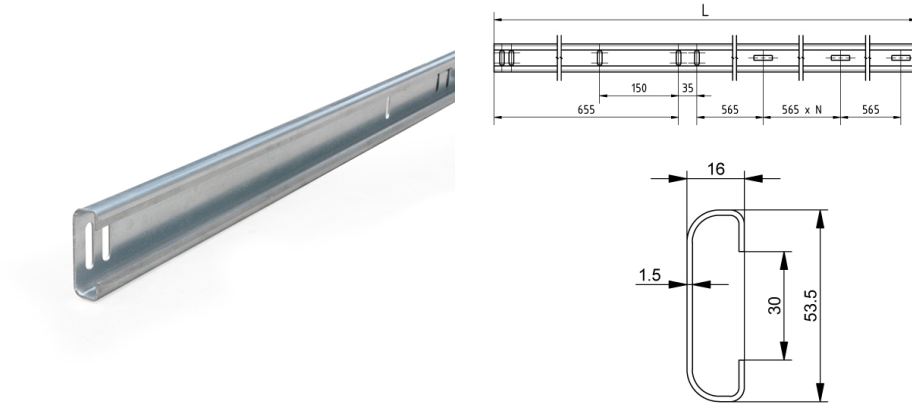

Description:

- | | |
|--------------------------|---|
| - Subcategory | : Bolted tracks, C-profile |
| - IND/RES | : IND |
| - Full package quantity | : 25 |
| - Unit | : piece (1) |
| - Weight / Unit | : 6,31kg |
| - Material | : Galvanised Steel |
| - Height | : 16mm |
| - Length | : 5805mm |
| - Width | : 53,5mm |
| - Thickness | : 1,5mm |
| - Product Family | : a 138§ |
| - Commercial description | : Universal left/right. See ISC technical handbook for system details |
| - Technical description | : One end is provided with holes 19x9mm connecting to the curve and vertical angle profile. Hole pattern for bolted connection each 565mm, hole diameter 35x9mm. Use in combination with 2V-H.. track profile. Suitable for strengthening of the horizontal tracks, enabling simple fixing and adjusting possibilities for suspension, bumpers etc. |