

215C-H5240 C-Profile

Images:

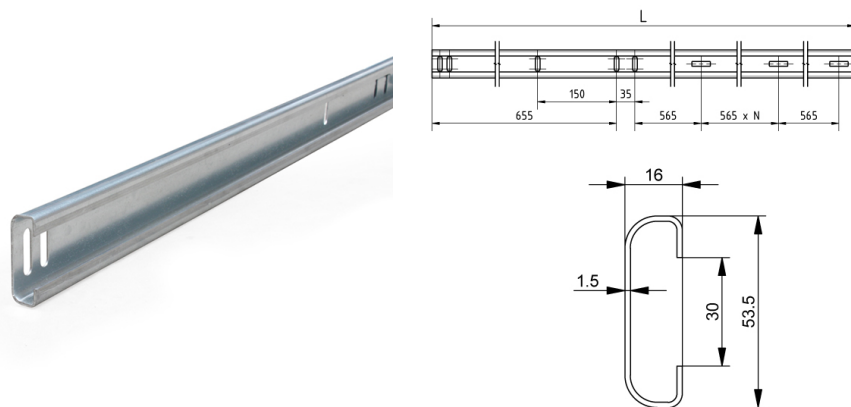

Description:

- Subcategory : Bolted tracks, C-profile
- IND/RES : IND
- Full package quantity : 25
- Unit : piece (1)
- Weight / Unit : 6,69kg
- Material : Galvanised Steel
- Height : 16mm
- Length : 5240mm
- Width : 53,5mm
- Thickness : 1,5mm
- Product Family : a 137§
- Commercial description : Universal left/right. See ISC technical handbook for system details
- Technical description : One end is provided with holes 19x9mm connecting to the curve and vertical angle profile. Hole pattern for bolted connection each 565mm, hole diameter 35x9mm. Use in combination with 2V-H.. track profile. Suitable for strengthening of the horizontal tracks, enabling simple fixing and adjusting possibilities for suspension, bumpers etc.