

## 215C-H4675 C-Profile

Images:

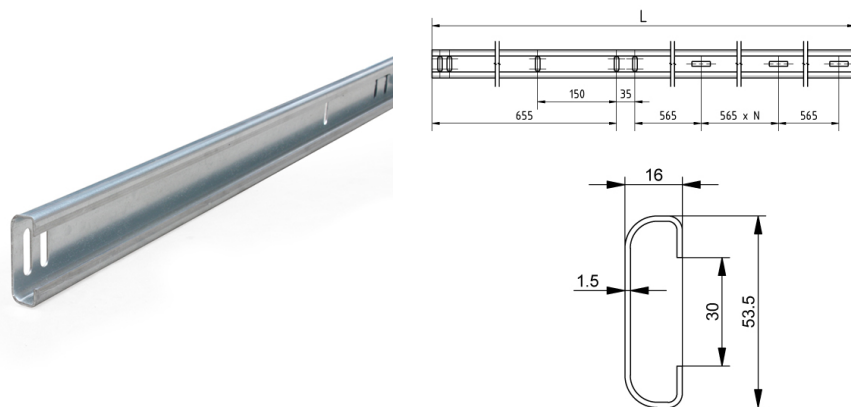

### Description:

- |                          |   |
|--------------------------|---|
| - Subcategory            | : Bolted tracks, C-profile  |
| - IND/RES                | : IND   |
| - Full package quantity  | : 25  |
| - Unit                   | : piece (1)   |
| - Weight / Unit          | : 5,08kg  |
| - Material               | : Galvanised Steel  |
| - Height                 | : 16mm  |
| - Length                 | : 4675mm  |
| - Width                  | : 53,5mm  |
| - Thickness              | : 1,5mm   |
| - Product Family         | : a 136§  |
| - Commercial description | : Universal left/right. See ISC technical handbook for system details   |
| - Technical description  | : One end is provided with holes 19x9mm connecting to the curve and vertical angle profile. Hole pattern for bolted connection each 565mm, hole diameter 35x9mm. Use in combination with 2V-H.. track profile. Suitable for strengthening of the horizontal tracks, enabling simple fixing and adjusting possibilities for suspension, bumpers etc. |