

1088RC-3500 Side seal

Images:

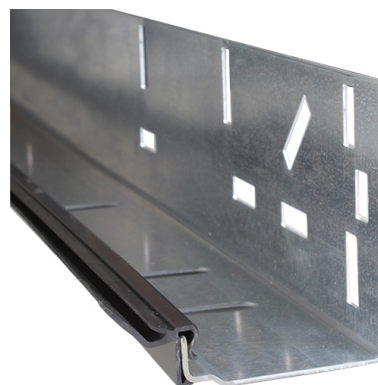
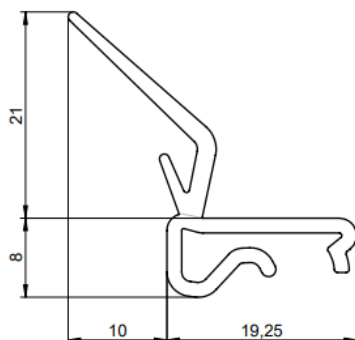

Description:

- IND/RES	: BOTH
- Full package quantity	: 10
- Unit	: piece (1)
- Weight / Unit	: 0,52kg
- Material	: PVC, TPE
- Colour	: Black
- Height	: 29mm
- Length	: 3500mm
- Width	: 30mm
- Product Family	: a 001
- Commercial description	: for 915VL
- Technical description	: Replaces 1088N side seal. Improved design for easier mounting on the 915VL profile.