

## 1032END-3000 Pass door profile

Images:

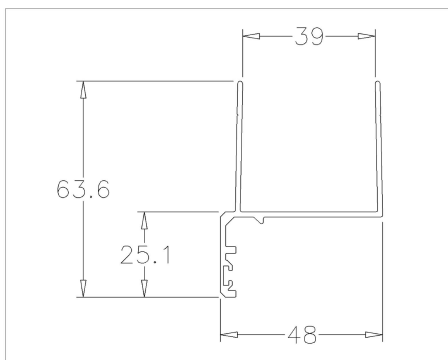

Description:

- Subcategory	: 02. Alu profiles IND
- IND/RES	: IND
- Full package quantity	: 50
- Unit	: piece (1)
- Weight / Unit	: 1,95kg
- Material	: Anodised Aluminium
- Height	: 63,6mm
- Length	: 3000mm
- Width	: 39mm
- Product Family	: a 010
- Commercial description	: L = 3000mm
- Technical description	: Use with rubber profile 1032RUB