

## 9VB3500 Angle

Images:

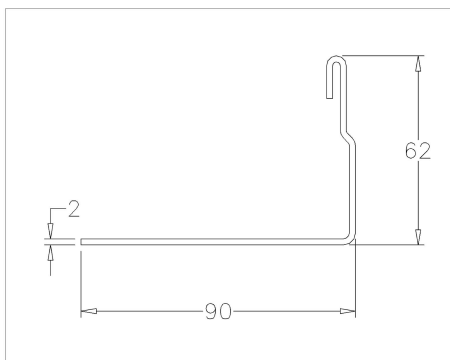

### Description:

- |                         |  |
|-------------------------|--|
| - Subcategory           | : 02. Vertical Angles 2mm  |
| - IND/RES               | : IND  |
| - Full package quantity | : 50   |
| - Unit                  | : piece (1)  |
| - Weight / Unit         | : 9,1kg  |
| - Material              | : Galvanised Steel   |
| - Height                | : 62mm   |
| - Length                | : 3500mm   |
| - Width                 | : 90mm   |
| - Thickness             | : 2mm  |
| - Product Family        | : a 007  |
| - Technical description | : The flange of 62mm has slotted holes 9x25mm every 300mm. The flange of 90mm has on both ends 4 slotted holes 9x25mm. The vertical angle is suitable for side seal 1085, 1094-40. Other lengths available on request. |