

50SU3000 Suspension profile

Images:

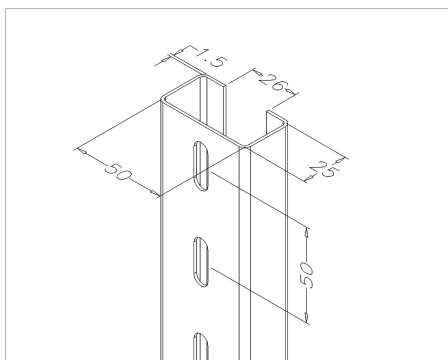

Description:

- Subcategory	: 08. Suspension
- IND/RES	: BOTH
- Full package quantity	: 50
- Unit	: piece (1)
- Weight / Unit	: 4,44kg
- Material	: Galvanised Steel
- Length	: 3000mm
- Width	: 50mm
- Thickness	: 1,5mm
- Product Family	: a 092
- Technical description	: Provided each 50mm with slotted holes 8.5x25mm at wide flange. 1 small flange slotted holes 8.5x25mm located each 300mm. 48SU can slide into 50SU. Coupling strip 1025-200 for quick construction. Or use with paro clamp plates.