

48SU2000 Suspension profile

Images:

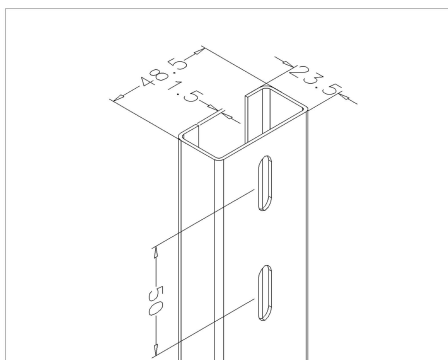

Description:

- Subcategory	: 08. Suspension
- IND/RES	: BOTH
- Full package quantity	: 50
- Unit	: piece (1)
- Weight / Unit	: 2,54kg
- Material	: Galvanised Steel
- Length	: 2000mm
- Width	: 48,5mm
- Thickness	: 1,5mm
- Product Family	: a 086
- Technical description	: Provided each 50mm with slotted holes 8.5x25mm at wide flange. On one small flange slotted holes 8.5x25mm are located each 300mm. 48SU can slide into 50SU to enable freely adjustment of length. Coupling strip 1025-200 for quick construction.